

# Data Acquisition Unit MW100



## **MW100** Data Acquisition Unit



*The MW100 is a scalable, high performance data acquisition/data-logging platform designed for both PC-controlled and stand-alone operation under harsh operating conditions.*

Bulletin 04M10B01-01E

[www.yokogawa.com/daq/](http://www.yokogawa.com/daq/)

A Yokogawa Commitment to Industry

**vigilance**<sup>®</sup>

**YOKOGAWA** 



“Smart Logging” - Anytime, Anyplace

# MW100 DATA ACQUISITION UNIT

The MW100 is a scalable, high performance data acquisition/data-logging platform designed for both PC-controlled and stand-alone operation under harsh operating conditions.

Open Ethernet connectivity with web-based configuration and data monitoring functions allow MW100 to handle a wide range of monitoring and historical logging functions. See real time trends with your web browser from any PC and no special software. A full range of input/output modules handle all of your process inputs with fast measurement speed and high noise immunity for rock-solid performance.

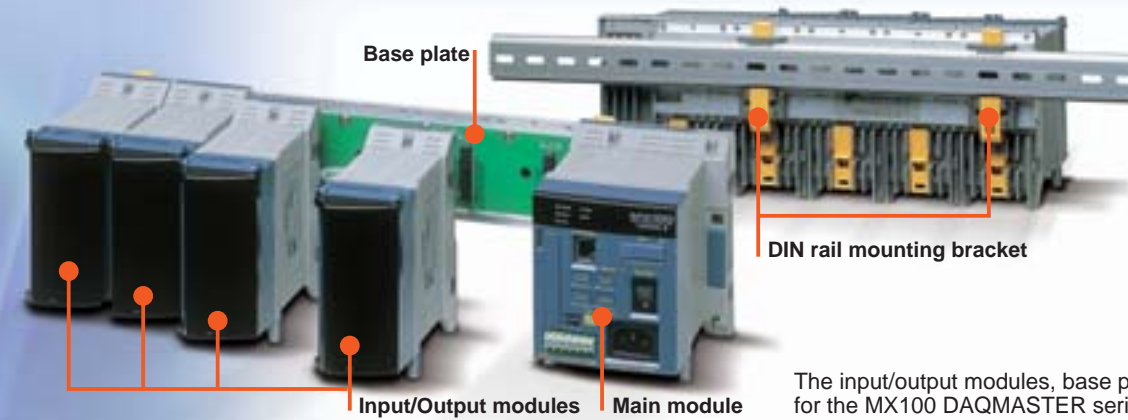

### Standard Configuration

A custom MW100 measuring system is comprised of three elements; the MW100 main module, MX Series input/output modules, and MX150 Series base plate. The system can be bench mounted as-is or DIN rail mounted for rack or panel installations. A DIN rail-mounting bracket is included with the MX150.

The input/output modules, base plate, and accessories are all the same as those for the MX100 DAQMASTER series (AC adapter is for the MW100 only).

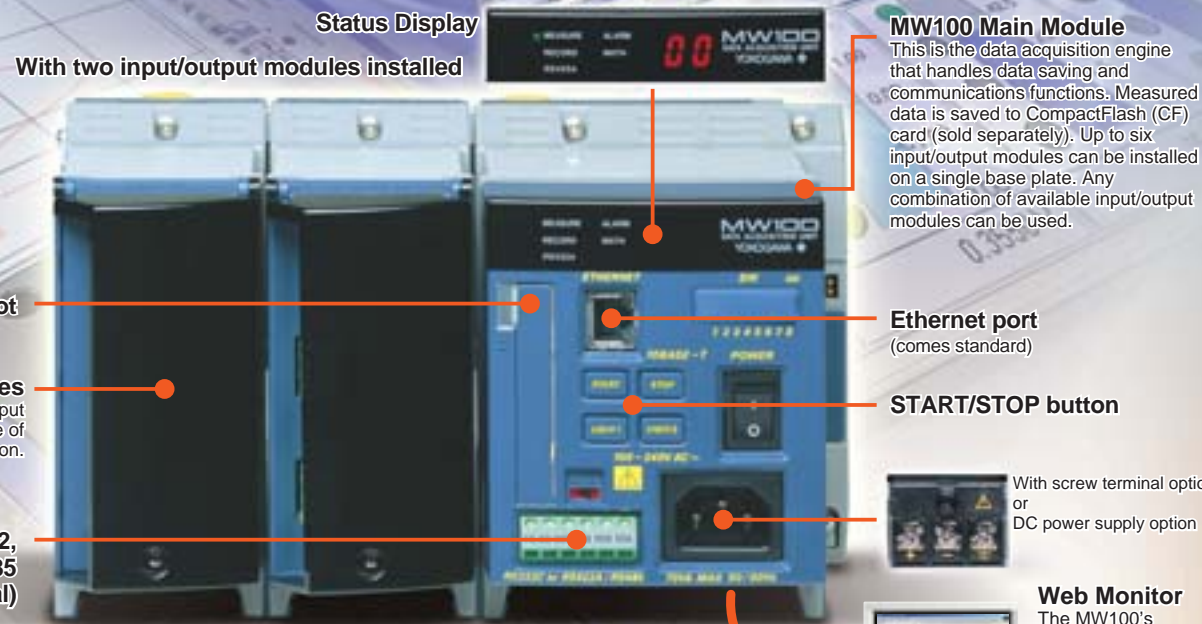

**MW100 Main Module**  
This is the data acquisition engine that handles data saving and communications functions. Measured data is saved to CompactFlash (CF) card (sold separately). Up to six input/output modules can be installed on a single base plate. Any combination of available input/output modules can be used.

**Ethernet port**  
(comes standard)

**START/STOP button**

With screw terminal option or DC power supply option

**Web Monitor**  
The MW100's settings and realtime monitoring of measured values can be implemented with a Web browser (requires a browser with Java VM and Java Script installed.)

### Input Modules

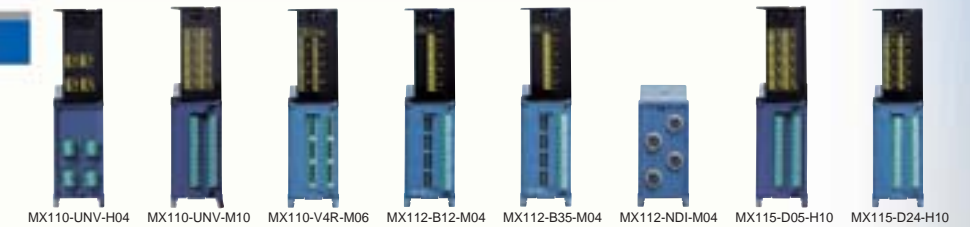

Name	Model	Number of channels	Shortest measurement interval	Description
Universal Input Modules	MX110-UNV-H04	4	10 ms	DC voltage, thermocouple, 3-wire RTD, DI (non-voltage contact, Level (5V logic)). Mixed input allowed.
	MX110-UNV-M10	10	100 ms	DC voltage, thermocouple, 3-wire RTD, DI (non-voltage contact, Level (5V logic)). Mixed input allowed.
4-Wire RTD and Resistance Input Module	MX110-V4R-M06	6	100 ms	DC voltage, 4-wire RTD, 4-wire resistance, DI (non-voltage contact, Level (5V logic)). Mixed input allowed.
	MX112-B12-M04			Built-in bridge resistance of 120 Ω
Strain Input Modules	MX112-B35-M04	4	100 ms	Built-in bridge resistance of 350 Ω
	MX112-NDI-M04			For connection with an external bridge head and strain gauge type sensor (NDIS connector)
5 V Digital Input Module	MX115-D05-H10	10	10 ms	Non-voltage contact, open collector, and Level (5V logic). Mixed input allowed.
24 V Digital Input Module	MX115-D24-H10	10	10 ms	Level (24 V logic), Vth = 12 V

### Output Modules

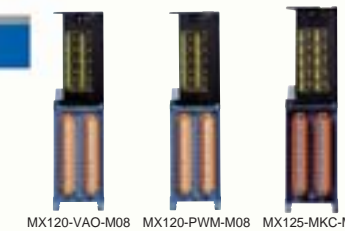

Name	Model	Number of channels	Output update interval	Description
Analog Output Module	MX120-VAO-M08	8	100 ms	Allows mixed voltage (±10 V) and current (4-20 mA) output
PWM Output Module	MX120-PWM-M08	8	100 ms	Pulse width modulation output module
Digital Output Module	MX125-MKC-M10	10	100 ms	"A" contact (SPST)

### Base Plate

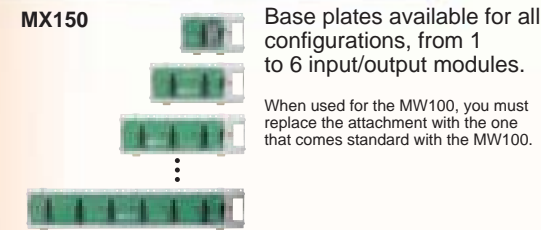

**MX150**  
Base plates available for all configurations, from 1 to 6 input/output modules.

When used for the MW100, you must replace the attachment with the one that comes standard with the MW100.

### Accessories

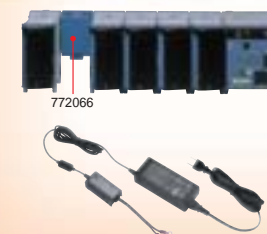

● **Connector Covers**  
Connector covers for open slots

● **AC Adapter (772075)**  
AC adapter for the DC power model. Operating temperature range: 0 to 40°C

### Accessories (Removable Terminals)

All input/output terminals are removable except for those of the MX112-NDI-M04. If multiple terminals are prepared ahead of time, no re-wiring is needed between measurements.



Model	Description
772061	Screw (M4) terminal block (RJC (reference junction compensation) included). For use in combination with 772062. Compatible with MX110-UNV-M10, MX115-D05-H10, and MX115-D24-H10.
772062	Connection cable between input modules and the screw terminal block. Compatible with MX110-UNV-M10, MX115-D05-H10, and MX115-D24-H10.
772063	Plate with clamp terminals (RJC included). Compatible with MX110-UNV-M10, MX115-D05-H10, and MX115-D24-H10.
772064	Clamp terminals. Compatible with MX110-UNV-H04.
772065	Clamp terminals. Compatible with MX120-VAO-M08, MX120-PWM-M08, and MX125-MKC-M10.
772067	Plate with clamp terminals. Compatible with MX110-V4R-M06.
772068	Plate with clamp terminals (Built-in bridge resistance of 120 Ω). Compatible with MX112-B××-M04.
772069	Plate with clamp terminals (Built-in bridge resistance of 350 Ω). Compatible with MX112-B××-M04.
772080	Plate with screw (M3) terminal (RJC included). Compatible with MX110-UNV-M10, MX115-D05-H10, and MX115-D24-H10.

### Anytime, Anyplace...

- ✓ In a wide range of temperatures: -20 to 60°C<sup>1,2,3,4</sup>
- ✓ Reinforced insulation: Between input terminal and case<sup>5</sup>, 3700 Vrms (one minute) or 600 Vrms/VDC (continuous)
- ✓ A wide variety of network functions: HTTP, FTP, DHCP, SNTP, E-mail, and others.
- ✓ DC power supply (12 V-28 V) option available.

### Smart Logging...

- ✓ High speed measurement with a single unit (10 channels/10 ms or 60 channels/100 ms): Shortest measurement interval of 10 ms
- ✓ Multi-interval: Enables mixing of three different measurement intervals in a single unit (measurement intervals can be set for each module)
- ✓ Supports CompactFlash (CF) cards<sup>6</sup> of up to 2 GB  
Continuous data acquisition is possible on 60 channels at 100 ms for approximately ten days with a 2-GB card, or for three months on 60 channels at 1 s.
- ✓ MATH function on the main module available with the /M1 option.
- ✓ Collective data acquisition on 360 channels (via Modbus with the /M1 option)

1. The operating temperature range for the input modules and main module. The operating temperature range of the output modules is -20 to 50°C.  
2. Note that the power cord supplied with the main module differs depending on the operating temperature range (see the specifications on page 7). If the operating temperature range specification of the supplied standard power cord does not meet your requirements, we recommend that you select a screw-type terminal rather than the plug type for the main module power inlet, and supply your own power input cable.  
3. The operating temperature range of the AC adapter used with DC power supplies is 0 to 40°C.  
4. Please consult with a representative for applications involving temperatures below -20°C.  
5. The withstand voltage value with the MX110 input module. For the withstand voltage values of other input and output modules, please refer to the specifications for those modules (GS 04M10B01-01E).  
6. CF card not included (sold separately).



This is the basic flow for acquiring measured data. Settings (excluding some communications settings) and real time monitoring of measured data can be performed using a browser (Internet Explorer 5.5 and 6).

Setup

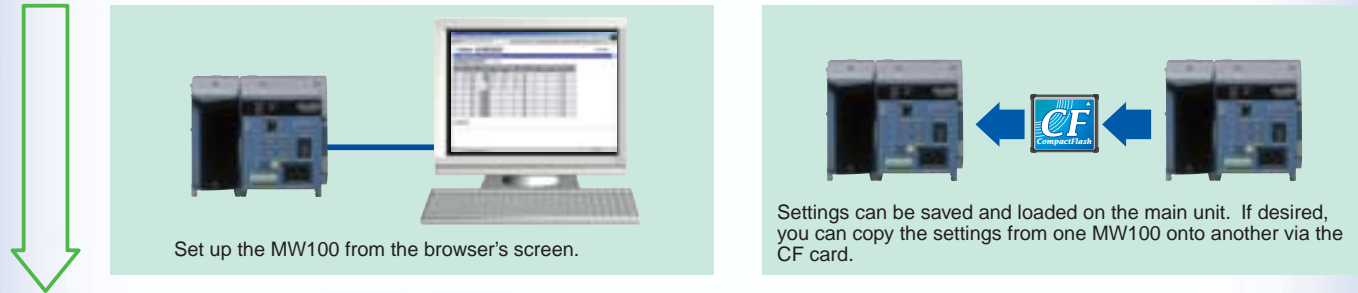

Data Acquisition

**Start/Stop Data Recording** Measured data is recorded to the CF card in the MW100. Starting and stopping of the record operation can be controlled either online or offline.

<Offline>

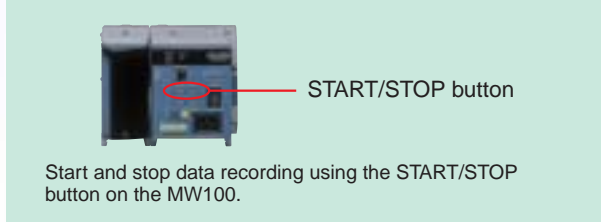

<Online>



**Realtime Monitoring** You can use a browser for realtime monitoring of measured data. While monitoring, you can also control starting and stopping of the record operation from the browser screen.



Data Transfer



Data Analysis

Measured data can be displayed using the Viewer Software (comes standard), enabling waveform display, digital display, or interval arithmetic. Data can be converted to Excel, Lotus, or ASCII format.



Multi-Access

The MW100 can be connected to multiple PCs at the same time. This allows monitoring and sharing of measured data by multiple users. A login function is included to enable assigning of access rights.

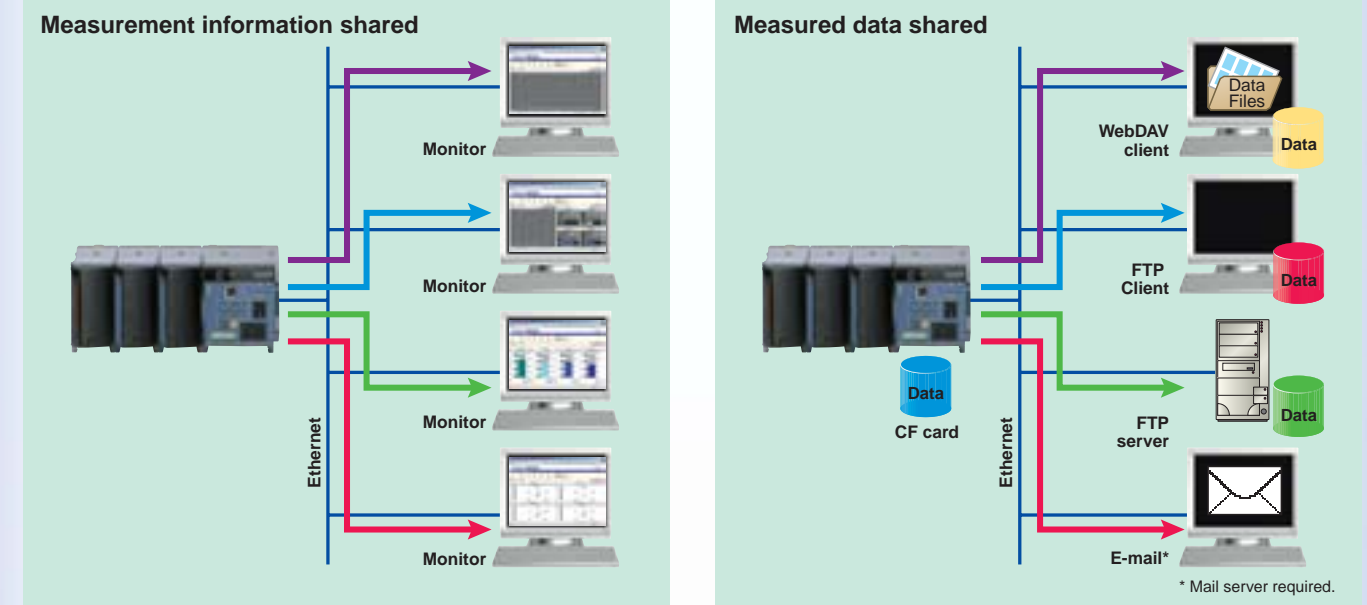

Acquire up to 360 Channels in One System

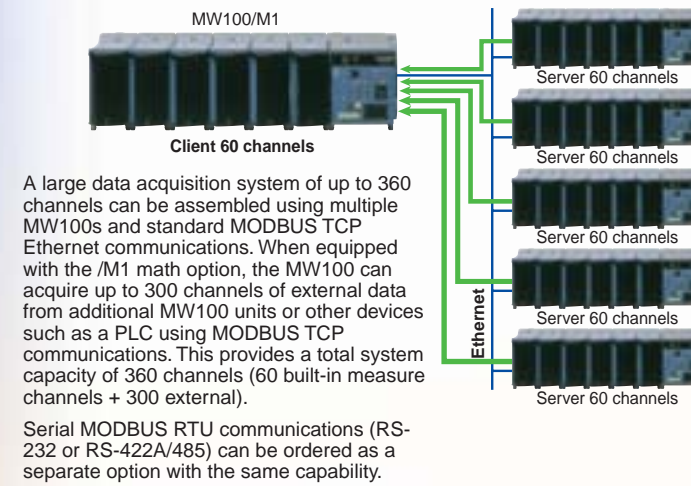

Connect to Other Devices

An optional serial MODBUS RTU interface provides data exchange functions with other devices such as recorders, PLCs and controllers. In this mode, MW100 can serve as expansion I/O or as a data acquisition terminal for another connected device.

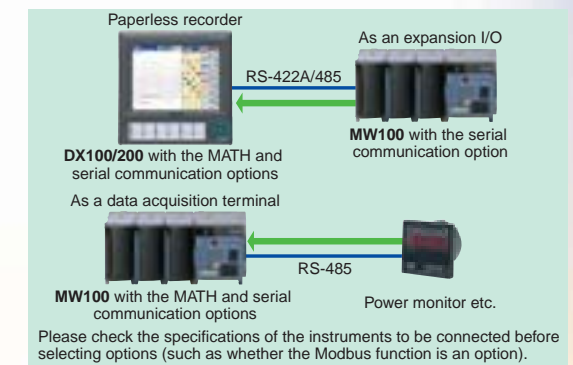

Remote Data Acquisition

When the measurement location is located remotely from the data monitoring station, a dial up phone connection can be used for communications. All MW100 web browser-based data monitoring and FTP functions can be used via this connection for remote data acquisition applications.

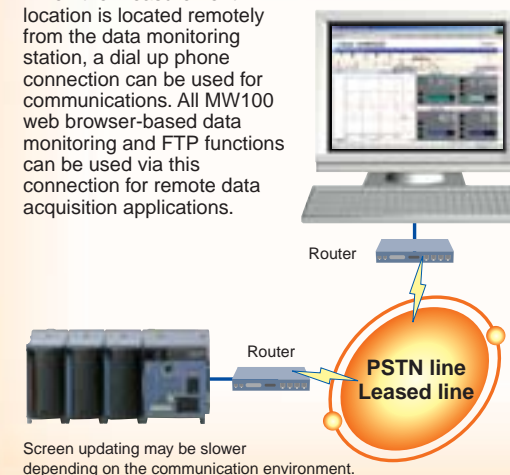

Time Synchronization

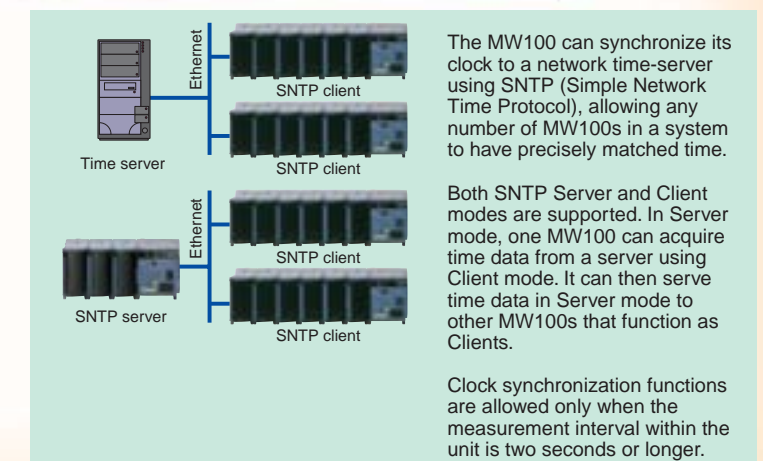



Memory

Select a CF card appropriate for the required data recording time. See the table below for the approximate time's worth of data that can be recorded for each size of card. For example, when recording ten channels of data at a 10 ms measurement interval, the approximate amount of data that can be recorded to a 128-MB CF card is 8.8 hours worth. On the MW100, measured data is recorded to the CF card via an SRAM. The SRAM is backed up with a battery (for approximately ten years), ensuring that even in the event of a power failure, data prior to the failure is not lost.

Recording channels	Measurement interval	128 MB	512 MB	1 GB
10 channels	10 ms <sup>1</sup>	Approx. 8.8 hours	Approx. 1.4 days	Approx. 2.8 days
	100 ms	Approx. 3.7 days	Approx. 14.8 days	Approx. 28.9 days
	500 ms	Approx. 18.5 days	Approx. 74.0 days	Approx. 144 days
	1 s	Approx. 37.0 days	Approx. 148 days	Approx. 289 days
	2 s	Approx. 74.0 days	Approx. 296 days	Approx. 578 days (1.5 years)
20 channels	5 s	Approx. 185 days	Approx. 740 days	Approx. 1446 days (3.9 years)
	50 ms <sup>2</sup>	Approx. 22.2 hours	Approx. 3.7 days	Approx. 7.2 days
	100 ms	Approx. 1.8 days	Approx. 7.4 days	Approx. 14.4 days
	500 ms	Approx. 9.2 days	Approx. 37.0 days	Approx. 72.3 days
	1 s	Approx. 18.5 days	Approx. 74.0 days	Approx. 144 days
60 channels	2 s	Approx. 37.0 days	Approx. 148 days	Approx. 289 days
	5 s	Approx. 92.5 days	Approx. 370 days (1 year)	Approx. 723 days (1.9 years)
	100 ms	Approx. 1.8 hours	Approx. 2.4 days	Approx. 4.8 days
	500 ms	Approx. 3.0 days	Approx. 12.3 days	Approx. 24.1 days
	1 s	Approx. 6.1 days	Approx. 24.6 days	Approx. 48.2 days
	2 s	Approx. 12.3 days	Approx. 49.3 days	Approx. 96.4 days
	5 s	Approx. 30.8 days	Approx. 123 days	Approx. 241 days

Storage capacity in terms of time by CF card size and numbers of channels

- At a measurement interval of 10 ms, the maximum number of channels that can be measured is 10. Eleven or more channels cannot be measured at a measurement interval of 10 ms.
- At a measurement interval of 50 ms, the maximum number of channels that can be measured is 30. Thirty-one or more channels cannot be measured at a measurement interval of 50 ms.

Trigger and Data Thinning Functions

The MW100 is equipped with built-in trigger functions. Data recording can be started based on alarm values, time, external contact input, or other parameters. Once recording is started, it can be set to progress continuously or according to a specified data length. When specifying a data length, a pre-trigger can also be set. The MW100 also provides a data thinning function.

Portions of measured data can be omitted at regular intervals during measurement (minimum of four seconds) before data is recorded. Using the trigger and data thinning functions together provides "coarse" recording of general data and "fine" recording of abnormal data.

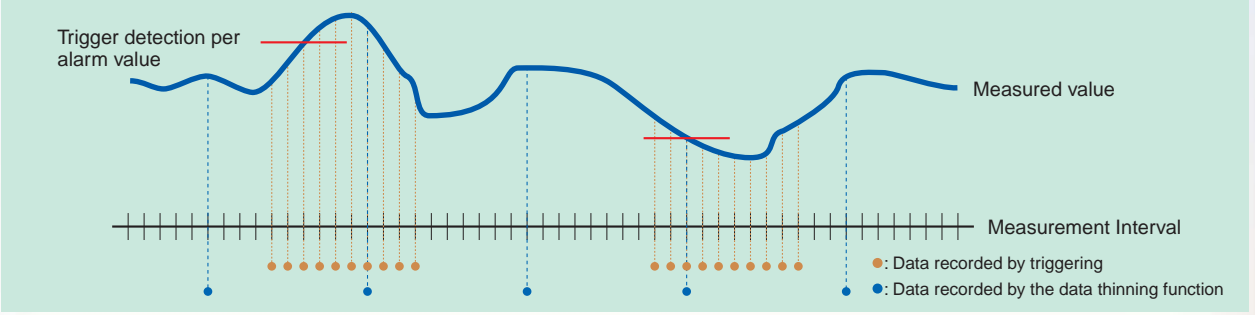

Data Recording Using the Trigger and Data Thinning Functions

Pulse Integration (/M1 Option)

This function is included with the MATH (/M1) option. You can easily perform pulse integration using the MX115 Digital Input Module or the MX110 Universal Input Module.

Example of pulses that can be integrated at a measurement interval of 10 ms:

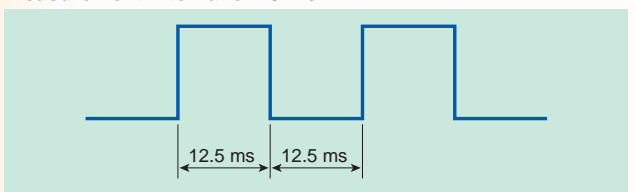

For accurate pulse detection, the pulse width must be longer than the measurement interval.

For pulse integration at a measurement interval of 10 ms/50 ms, aside from the module performing the pulse integration, input modules of measuring interval 100 ms or more must be set up for measurement in the same unit.

Broken Line Chart Output (/M1 Option)

This function is included with the MATH (/M1) option. Patterns can be output from the analog output and PWM output modules (MX120) by inputting the coordinates of the pattern you wish to generate. In the pattern output shown in the figure below, points (X1,Y1) through (X10,Y10) are input in advance, and the output is generated accordingly.

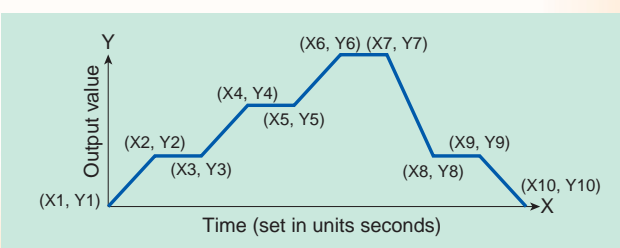

Multi-Interval



- Ex: 100 ms Measurement interval: 100 ms 500 m Measurement interval: 500 m 10 s Measurement interval: 10 s

The MW100 enables mixing of three different measurement intervals in a single unit. Measurement intervals can be set for each individual module. This allows you to measure various items under test at the most appropriate measurement intervals. Also, you can set data recording conditions<sup>1</sup> for each measurement interval, thereby using the available space on the CF card as efficiently as possible.

- Single: Save a file up to the specified size then stop recording. Full Stop: Stop recording once the CF card is full. Rotate: When the capacity of the CF card has been exceeded, the oldest files are deleted to free up space, then recording continues.

Common Specifications

**Normal Operating Conditions**  
 Operating temperature range: -20 to 60°C (when not using the MX120 or MX125 output modules)  
 Operating humidity range: 20-80% RH for -20-40°C, 5-30% RH for 40-60°C  
 Rated power supply voltage: AC power supply: 100-240 VAC (with or without AC adapter)  
 Range of operating power supply voltage: DC power supply: 12-28 VDC  
 DC power supply: 90-250 VAC (with or without AC adapter)  
 Power supply frequency: 50 Hz ±2%, 60 Hz ±2% (AC power supply)  
 Power consumption: Approximately 70 VA max when six modules are used (using AC power supply)  
 Approximately 35 VA max when six modules are used (using DC power supply)  
 Approximately 70 VA max when six modules are used (using DC power supply and AC adapter)  
 Weight: Approximately 4.3 kg (total weight with six modules installed)  
 Supported Standards: CSA, UL (CSA, NRTL/C), CE, C-Tick  
 1. Not including operating temperature range specification of accessory AC power cord and AC adapter. The operating temperature range specifications by AC power supply cord and AC adapter are as shown below.

Suffix code in the Model name (see page 8)	Standard applicable to included power cord	Operating temperature
-1D	UL/CSA	-20 to 60°C
-1F	VDE	-15 to 60°C
-1R	SAE	-15 to 60°C
-1Q	BS	-15 to 60°C
-1H	GB (CCC)	-15 to 60°C

The operating temperature range of the AC adapter is 0 to 40°C.  
 2. The operating humidity range of the AC adapter is 20-80% RH at 0-40°C. (no condensation)  
 3. NO condensation

Model-Specific Specifications

Main Module (MW100)

**Basic Functions**  
 Main functions: Control of the power supply and I/O modules, communications with the PC, and storage of data on the CF card.  
 Measurement interval: 10/50/100/200/500 ms, or 1/2/5/10/20/30/60 sec  
 Note that the configurable measurement intervals differ depending on the modules.  
 Also, the following limitations apply to the measurement interval and number of measurement channels.

Measurement Interval	Max number of measurement channels	Notes
10ms	10	
10 ms and 50 ms mixed	10	Modules whose measurement interval is not set to 10 ms or 50 ms can be set to 100 ms or higher.
50 ms	30	

**Multi-Interval (measurement groups):** Three measurement intervals can be set for each module within a unit. Synchronization between modules: Synchronized within the same measurement interval (within the same unit). Synchronization between channels: Synchronized between channels in the same module for the MX110-UNV-H04 and the MX115-Dxx-H10. Channels within the MX110-UNV-M10, MX110-V4R-M06, and M112 input modules are asynchronous due to the scanner type. First-order lag filter can be set on each channel. After recovery from a power failure, the operation before the failure is continued.  
**Filter function:** Operation after failure recovery: After recovery from a power failure, the operation before the failure is continued.

**Input MATH Function** (Functions Available from the Main Module without the MATH Option (/M1)):  
 Differential computation between channels, linear scaling computation, remote RJC, initial balance (with the MX112 Strain Module)

**Alarm Functions**  
 Channels: Measurement and MATH channels  
 Number of alarms: Four levels per channel  
 Alarm types: Upper limit, lower limit, differential upper limit, differential lower limit, rate of change upper limit, rate of change lower limit. Differential upper limit and differential lower limit only available for differential input measurement channels. Only upper limit and lower limit alarms can be set on MATH channels.  
 Hysteresis: Can be set for each channel (however, fixed at 0 for MATH channels and with rate of change alarms)  
 Number of relay outputs: 1 to 60 points depending on the number of mounted MX125 Digital Output Modules.  
 Output mode: Excitation/non-excitation, AND/OR, Hold/Non-hold, refresh alarm  
 Alarm ACK: If set to Hold using the alarm status or relay output Hold/Non-hold function, the hold status is cleared.  
 Alarm update interval: 100 ms (not synchronized with the measurement interval)

**Digital Output Function** (Available Only When the MX125 Digital Output Module Is Installed)  
 Alarm output, communication command output (output in response to digital output requests from the PC), error output, and other outputs  
 100 ms (not synchronized with the measurement interval)

**Analog Output Function** (Available Only When the MX120-VAO-M08 Analog Output Module Is Installed)  
 Communication command output (output in response to analog output requests from the PC), transmission output, error output, and other outputs  
 100 ms (not synchronized with the measurement interval)

**MATH Function Specifications (/M1 Option)**  
 Number of MATH channels: 60 (can also be used as communication input channels)  
 Number of channels for computation: 60 (can also be used as communication input channels)  
 Number of channels for communication input: 240  
 Basic math functions (+, -, x, ÷, power)  
 Relational operators (>, ≥, =, ≤, <, ≠)  
 Logical operators (AND, OR, XOR, NOT)  
 Arithmetic operators (SQRT, ABS, LOG, EXP)  
 TLOG computations (max, min, max-min, average, integration, pulse integration)  
 CLOG computations (max, min, max-min, average)  
 Conditional expressions (EXPR1?EXPR2:EXPR3)  
 The following types of channels can be incorporated into expressions. Measurement channels, MATH channels, communication input channels, flag input channels, MATH constants, and broken-line input channels.  
 Up to 120 per channel  
 For communication input channels, a maximum of 8 characters can be used per channel.  
 MATH constants: 60  
 Flag input channels: 60  
 Flag value (0 or 1) can be substituted in computational expressions. Varies according to the action of the Event/Action function.

**Broken-line input channels:** 3  
 The output from the MX120 output modules can be executed according to the broken lines specified on these channels.  
 Four levels per channel. Upper limit and lower limit types only. Assigned to one of the measurement groups (of measurement interval 100 ms or more)  
**Computation alarm function:** MATH interval: 3  
 The output from the MX120 output modules can be executed according to the broken lines specified on these channels.  
 Four levels per channel. Upper limit and lower limit types only. Assigned to one of the measurement groups (of measurement interval 100 ms or more)

Recording Function Specifications

**Main functions:** Measured values, computed values, thinned values, setting values, data acquisition log, and alarm summary can be saved to CF card.  
**Supported external media:** CF card Type II x1 slot (Type I can also be used)  
**Internal backup memory:** Maximum allowable card size: 2 GB  
 Uses the main unit's internal backup memory (SRAM) to save data to CF card without loss before a power failure.  
**Saving/Loading settings:** Saves all settings to CF card. Loads settings from the CF card.  
**Measured and Computed Value Recording Function:** Starts and stops recording to CF card according to the START/STOP key, Event/Action function, or communication command output.  
**Recording operation:** Measured values and computed values are recorded in separate files on the CF card. If measured values are divided by group, a separate file is created and saved on the CF card for each group.  
**Recording mode:** Measurement channels can be divided into up to 3 groups by module. Select a record complete action for each measurement group of Single, Full stop, or Rotate.  
**Trigger function:** Included. Pre-triggers can also be set.  
**Recording interval:** Set the recording interval for each measurement group as an integer multiple (multiples restricted) of the measurement interval.  
**File name:** Generated automatically in sequence using the date and time (cannot be specified by the user).  
**Recording channels:** Recording can be turned ON/OFF independently on each channel.  
**Writing message:** During execution of the recording action, a message synchronized with the recorded data can be included in the file. Five messages of up to 15 characters each are available for including in a single file, up to ten messages per file.

Thinned Value Recording Function

**Record start/stop:** Executed simultaneously upon recording of the measured values and computed values. No trigger functions are available.  
**Recording Mode:** Select a record stop action of Single, Full stop, or Rotate.  
**Thinning time:** Data recording is set for 1 per thinning time (the thinning time restricted).  
**File name:** Generated automatically in sequence using the date and time (cannot be specified by the user).  
**Recording channels:** Can be specified for each channel (settings for recording of measured and computed values are set separately).  
**Writing message:** During execution of the recording action, a message synchronized with the recorded data can be included in the file. Five messages of up to 15 characters each are available for writing to a single file, up to ten messages per file.

Event/Action Function

**Overview:** By linking the Event and Action in the setting items, you can control the operations of the main unit.  
**Events:** Digital input information, alarm occurrence, relay output, internal timer time up, match time, user function key, and others.  
**Actions:** Recording start/stop, activate trigger, MATH start/stop/reset/clear, reset timer, alarm ACK, flag input, write message, and others.

Communication Specifications

**Overview:** Ethernet interface comes standard with the Main Module (MW100). Also, either an RS-232 or RS-422A/485 interface can be added to the main module as an option.

**Ethernet Interface Specifications**  
**Interface:** Ethernet (10Base-T)  
**Main protocols:** FTP, SMTP, SNMP, DHCP, DNS, HTTP, ModbusTCP, and a dedicated MW100 protocol.  
**Communication services:** Send/receive setting values, send measured values and computed values, maintenance/diagnosis of the communication connection, and others.  
**Login function:** Use when accessing a setting/measurement server, maintenance/diagnostic server, FTP server, or HTTP server. Up to 10 users can be registered.  
**DHCP function:** The IP address is automatically obtained from the DHCP server.  
**Client function:** Gets time information from the specified server such as when power is turned ON and when recording starts.  
**Server function:** Supplies time information to any MW100s connected to the network.  
**Mail function:** Sends timing information via e-mail including the time of alarm activation/release, specified time, file creation time, time at which free memory space drops below specified amount, time power turned ON, and time errors occur.  
**FTP function:** Files from the CF card containing measured values, computed values, and thinned values are automatically sent to the FTP server.  
**Server function:** A primary and secondary destination server can be specified. File transfers from the CF card, directory manipulation within the CF card, deletion of files from the CF card, and other functions can be carried out through requests from the computer.  
**HTTP function:** Enables entry of settings on the MW100 and real time monitoring of measured and computed values using a Web browser, and file acquisition on the CF card using WebDAV, and other functions.  
 Windows 2000/XP, Internet Explorer 5.5 and 6.0

**Supported OS and browser:** RS-232 interface specifications (/C2 Option)  
**Connection method:** Point-to-point  
**Baud rate:** Select 1200, 2400, 4800, 9600, 19200, 38400, 57600, or 115200 bps  
**Protocol:** Dedicated protocol and Modbus/RTU  
**Communication services:** Send/receive setting values, send measured and computed values.

**RS-422A/485 interface (/C3 Option)**  
**Connection method:** Multipoint, 4-wire 1-32, 2-wire 1-31  
**Baud rate:** Select 1200, 2400, 4800, 9600, 19200, 38400, 57600, or 115200 bps  
**Protocol:** Dedicated protocol and Modbus/RTU  
**Communication services:** Send/receive setting values, send measured and computed values.  
**Communication input function:** All settings on the main unit need dip switch and power switch operation can be performed with communication commands.

**Communication output function:** Using communication commands, the most recent measured data, the most recent computed values, and other information can be output.

**Modbus Function**  
**Communication media:** Ethernet RS-232 RS-422A/485  
**For Ethernet:** Modbus/TCP sever, client  
**Transmission mode:** /M1 option must be selected to use the Modbus/TCP client function.  
**For RS-232 and RS-422A/485:** Modbus/RTU slave, master  
**Transmission mode:** /M1 option must be selected to use the Modbus/TCP master function. Reading from registers, and writing to registers.

**Other Specifications**  
**Tags:** Select channel or tag display for all channels together.  
**Internal clock accuracy:** ±100 ppm  
**Summer/winter time:** The time on the internal clock is updated on the specified month, week, day of the week and time.  
**Power consumption:** Approximately 8 W for the main module alone.  
**Common-mode voltage:** 150 VACrms (50/60 Hz) between DC power supply terminal and earth terminal.  
**Insulation resistance:** 20 MΩ or more (500 VDC) between power supply terminal and earth terminal  
**AC power:** 1500 VACrms (50/60 Hz) between power supply terminal and earth terminal for 1 minute.  
**DC power:** 1000 VACrms (50/60 Hz) between power supply terminal and earth terminal for 1 minute.  
**Weight:** Approximately 1 kg (MW100 main module alone)

Input/Output modules

**Universal Input Modules (MX110)**  
**Measurement range:** 20/60/60 (high resolution)/200 mV, 1/2/6/6 (high resolution)/20/100 V  
**DC voltage:** R, S, B, K, E, J, T, L, U, N, W, KpvaAu7Fe, PLATINEL, PR40-20, ANIMe, WR69-25, WWR626, Type-N (AVG14), TXK GOST P150, P1100, Pt100 (high resolution), JPt100, JPt100 (high resolution), Pt25 (JPt100×1/4), Ni100 SAMA, Ni100 DIN, Ni120, Cu10 GE, Cu10 GE (high resolution), Cu10 LBN, Cu10 LBN (high resolution), Cu10 WEED, Cu10 WEED (high resolution), Cu10 BAILEY, Cu10 BAILEY (high resolution), Cu10 at 20°C alpha=0.00392, Cu10 at 20°C alpha=0.00393, Cu25 at 0°C alpha=0.00425, Cu53 at 0°C alpha=0.00426035, Cu100 at 0°C alpha=0.00425, J263B, Pt100 GOST, Cu100 GOST, Cu50 GOST, Cu10 GOST Pt100 (high noise resistance), JPt100 (high noise resistance) P1500, Pt1000  
**Thermocouple:** Non-voltage contact, level (5V logic) 20/200/2k Ω  
**Resistance:** 1: Specifications Common to the MX110-UNV-H04, MX110-UNV-M10, and MX110-V4R-M06  
 2: Specifications Common to the MX110-UNV-H04 and MX110-UNV-M10  
 3: Specifications Specific to the MX110-UNV-H04  
 4: Specifications Specific to the MX110-V4R-M06

**Strain Input Modules (MX112)**  
**Strain gauge or strain gauge sensor (static strain):** Single-gauge (2 or 3 wire), opposed-side two-gauge, adjacent-side two-gauge or four-gauge  
**Gauge connection method:** 100 to 1000 Ω. Built-in resistance of 120 Ω for -B12, and 350 Ω for -B35.  
**Bridge voltage:** 2 VDC fixed (accurate to ±5%)  
**Applicable gauge factor:** 2.0 fixed, gauge factor correction possible with scaling function  
**Measurement ranges:** 2000/20000/200000 μ strain  
**Digital Input Modules (MX115)**  
**Types of input:** Non-voltage contact, level (5V logic), open collector Level (24 V logic)  
**Type of input:** 1: Specifications Specific to the MX115-D05-H10  
 2: Specifications Specific to the MX115-D21-H10

**Analog Output Module (MX120-VAO-M08)**  
**Main functions:** Output of set and computed values, retransmission of measured and computed values, and other functions.  
**Rated output range:** Voltage: -10 to 10 V, current: 0 to 20 mA, sourcing (4 to 20 mA is output at 1 to 5 V output)  
**External power supply (used for current output):** 24 V ±10% and current capacity of 250 mA or more.

**PWM Output Module (MX120-PWM-M08)**  
**Main functions:** Output of set and computed values, retransmission of measured and computed values, and other functions.  
**Output waveform:** Outputs a pulse width. External power supply required.

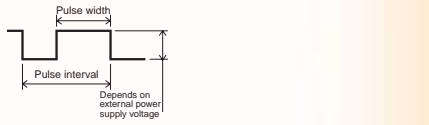

**Pulse interval:** 1 ms to 300 s  
**External power supply:** 4 V to 28 V  
**Output capacity:** Max 1 A/channel, however, the total of one module is 4 A or less

**Note:** If temperature (thermocouple), resistance, or strain measurements are taken by the MX110 or MX112 at an integral time of 1.67 ms, the measured values may be susceptible to inaccuracies due to power supply frequency noise. If this is the case, set the integral time to 16.67 ms or longer (for a power supply frequency of 60 Hz), or 20 ms or longer (for a power supply frequency of 50 Hz). On DAQMASTER, the integral time is automatically set when selecting the measurement interval, but the relationship between the integral time and the measurement interval differs from the modules. If measured values are inconsistent, consult the user's manual for guidance on how to select a measurement interval that will yield a sufficient integral time.

## Model Name

Model	Suffix Code	Option Code	Description
MW100			Main module (with MW100 Viewer Software) <sup>1,2</sup>
Language	-E		English (with English user's manual) <sup>3</sup>
Power supply voltage	-1		100 VAC~240 VAC
	-2		12 VDC~28 VDC, with AC adapter <sup>4</sup>
	-3		12 VDC~28 VDC, without AC adapter <sup>5</sup>
Power supply inlet and power supply cord	D		AC power: 3-pin power inlet with UL/CSA cable DC power: Screw terminal, UL/CSA cable for AC adapter
		F	AC power: 3-pin power inlet with VDE cable DC power: Screw terminal, VDE cable for AC adapter
	R		AC power: 3-pin power inlet with SAA cable DC power: Screw terminal, SAA cable for AC adapter
		Q	AC power: 3-pin power inlet with BS cable DC power: Screw terminal, BS cable for AC adapter
	H		AC power: 3-pin power inlet with GB (CCC) cable DC power: Screw terminal, GB (CCC) cable for AC adapter
		W	
Options	/C2		RS-232 communication interface <sup>8,7</sup>
	/C3		RS-422A/485 communication interface <sup>8,7</sup>
	/M1		MATH function <sup>8,7</sup>

- CF card does not come standard.
- Modbus/TCP server function comes standard.
- Displays Celsius or Fahrenheit, Winter/Summer time can be set.
- "W" cannot be selected with "-2"
- "3" can only be selected with "W"
- "C2" and "C3" may not be selected together
- "C2" or "C3" must be selected to use the Modbus/RTU slave function. Also, "M1" must be selected for use of the Modbus/RTU master function.
- "M1" must be selected to use the Modbus/TCP client function.

Model	Suffix Code	Option Code	Description
MX110			Analog input module
Input type	-UNV		DCV/TC/DI/3-wire RTD <sup>1</sup>
	-V4R		DCV/DI/4-wire RTD/4-wire resistance <sup>1</sup>
Measurement interval, number of channels	-H04		4 channels, high speed (shortest measurement interval: 10 ms)
	-M06		6 channels, medium speed (shortest measurement interval: 100 ms) <sup>1</sup>
	-M10		10 channels, medium speed (shortest measurement interval: 100 ms) <sup>2</sup>
Option	/INC		The plate with clamp terminals is not attached. <sup>2</sup>

- "M06" must be specified when "-V4R" is specified.
- "M06" can not be specified when "-UNV" is specified.
- "INC" can be specified only when "-M10" is specified.

Model	Suffix Code	Description
MX112		Strain input module
Input type	-B12	Built-in bridge resistance: 120 Ω
	-B35	Built-in bridge resistance: 350 Ω
	-NDI	For connection to external bridge head and strain gauge type sensor (NDIS connector)
Measurement interval, number of channels	-M04	4 channels, Medium speed (Shortest measurement interval: 100 ms)

Model	Suffix Code	Option Code	Description
MX115			Digital input module
Input type	-D05		Non-voltage contact, 5 V logic, open collector
	-D24		24 V logic
Measurement interval, number of channels	-H10		10 channels, high speed (shortest measurement interval: 10 ms)
Option	/INC		The plate with clamp terminals is not attached.

Model	Suffix Code	Description
MX120		Analog output module
Output type	-VAO	Voltage/Current output (allows mixed voltage and current output)
	-PWM	Pulse width modulation output
Measurement interval, number of channels	-M08	8 channels, output update cycle: 100 ms

Model	Suffix Code	Description
MX125		Digital output module
Output type	-MKC	"A" contact (SPST)
Output update cycle, number of channels	-M10	10 channels, output update cycle: 100 ms

Model	Suffix Code	Description
MX150		Base plate
Base type	-1	For connection with one main module and one input/output module
	-2	For connection with one main module and two input/output modules
	-3	For connection with one main module and three input/output modules
	-4	For connection with one main module and four input/output modules
	-5	For connection with one main module and five input/output modules
	-6	For connection with one main module and six input/output modules

## Accessories

Model	Description
772061	Ten-Channel Screw (M4) Terminal Block (RJC included)

Note: The 772061 model is applicable only to the MX110-UNV-M10 (Ten-Channel Medium-Speed Universal Input Module), the MX115-D05-H10 (Ten-Channel High-Speed 5 V Digital Input Module) or the MX115-D24-H10 (Ten-Channel High-Speed 24 V Digital Input Module).

Model	Suffix Code	Description
772062		Cable for connection between the input module and the screw terminal block
Cable length	-050	50 cm cable
	-100	100 cm cable

Note: The 772062 model is applicable only between the MX110-UNV-M10 (Ten-Channel Medium-Speed Universal Input Module) and the Screw Terminal Block (772061), between the MX115-D05-H10 (Ten-Channel High-Speed 5 V Digital Input Module) and the Screw Terminal Block (772061) or between the MX115-D24-H10 (Ten-Channel High-Speed 24 V Digital Input Module) and the Screw Terminal Block (772061).

Model	Description
772063	Plate with clamp terminals (RJC included)

Note: The 772063 model is applicable only to the MX110-UNV-M10 (Ten-Channel Medium-Speed Universal Input Module), the MX115-D05-H10 (Ten-Channel High-Speed 5 V Digital Input Module) or the MX115-D24-H10 (Ten-Channel High-Speed 24 V Digital Input Module).

Model	Description
772064	Clamp terminals

Note: The 772064 model is applicable only to the MX110-UNV-H04 (Four-Channel High-Speed Universal Input Module).

# YOKOGAWA

YOKOGAWA ELECTRIC CORPORATION

Network Solutions Business Div./Phone: (81)-422-52-7179, Fax: (81)-422-52-6793

E-mail: tm@csv.yokogawa.co.jp

YOKOGAWA CORPORATION OF AMERICA

YOKOGAWA EUROPE B.V.

YOKOGAWA ENGINEERING ASIA PTE. LTD.

Phone: (1)-770-253-7000, Fax: (1)-770-251-2088

Phone: (31)-33-4641806, Fax: (31)-33-4641807

Phone: (65)-62419933, Fax: (65)-62412606

RS-14E

## Accessories

Model	Description
772065	Clamp terminals

Note: The 772065 model is applicable only to the MX120-VAO-M08 (Eight-Channel Medium-Speed Analog Output Module), the MX120-PWM-M08 (Eight-Channel Medium-Speed PWM Output Module) or the MX125-MKC-M10 (Ten-Channel Medium-Speed Digital Output Module).

Model	Description
772066	Connector cover for base plate

Model	Description
772067	Plate with clamp terminals

Note: The 772067 model is applicable only to the MX110-V4R-M06 (Six-Channel Medium-Speed 4-Wire RTD and Resistance Input Module).

Model	Description
772068	Plate with clamp terminals (Built-in bridge resistance of 120 Ω)

Note: The 772068 is applicable only to the MX112-B12-M04 (Four-Channel Medium Speed Strain Input Module, 120 Ω), or the MX112-B35-M04 (Four-Channel Medium Speed Strain Input Module, 350 Ω).

Model	Description
772069	Plate with clamp terminals (Built-in bridge resistance of 350 Ω)

Note: The 772069 is applicable only to the MX112-B35-M04 (Four-Channel Medium Speed Strain Input Module, 350 Ω), or the MX112-B12-M04 (Four-Channel Medium Speed Strain Input Module, 120 Ω).

Model	Description
772080	Screw (M3) terminal plate (RJC included)

Note 1) The 772080 is applicable only to the MX110-UNV-M10 (Ten-channel Medium Speed Universal Input Module), the MX115-D05-H10 (Ten-channel High Speed 5 V DI Module), and the MX115-D24-H10 (Ten-channel High-Speed 24 V DI Module).

Note 2) Terminal count included

Note 3) b terminals for RTD are common (2 terminals)

Model	Suffix Code	Description
772075		AC adapter
Power supply cord	-D	Cable for UL/CSA
	-F	Cable for VDE
	-R	Cable for SAA
	-Q	Cable for BS
	-H	Cable for GB (CCC)

Model	Specifications	Description
438920	250 Ω ± 0.1%	Shunt Resistance (for clamp terminals)
438921	100 Ω ± 0.1%	
438922	10 Ω ± 0.1%	
415920	250 Ω ± 0.1%	Shunt Resistance (for screw (M4) terminals)
415921	100 Ω ± 0.1%	
415922	10 Ω ± 0.1%	
772090		Adapter for CompactFlash Memory Card
772091	128 MB <sup>1</sup>	CompactFlash Memory Card (CF card only)
772092	256 MB <sup>1</sup>	
772093	512 MB <sup>1</sup>	
772094	1 GB <sup>1</sup>	

1. Operating temperature range: -40 to 85°C

## Application Software

Model	Description
MW180	MW100 Viewer Software

## Exterior Dimensions

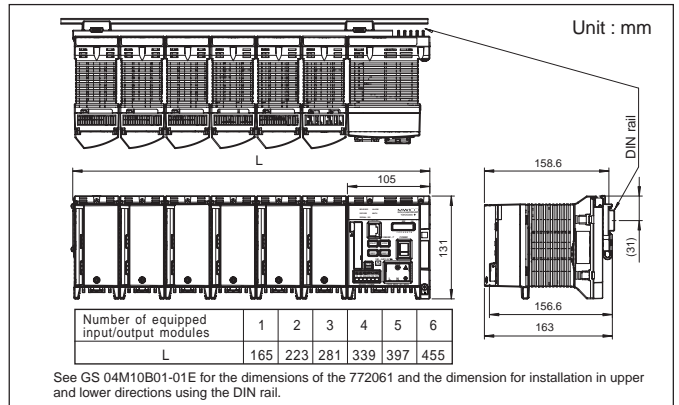

DAQMASTER is a registered trademark of Yokogawa Electric Corporation. TCP/IP software of this product and documents on TCP/IP software were developed/created by Yokogawa Electric Corporation on the basis of BSD Networking Software (Release 1) licensed from University of California. Microsoft, MS, Windows, and Excel are registered trademarks of Microsoft Corporation in the United States. Lotus and 1-2-3 are registered trademarks of Lotus Development Corporation. Ethernet is a registered trademark of XEROX Corporation. Java and Java-related trademarks are trademarks or registered trademarks of Sun Microsystems, Inc. in the United States and/or other countries. All other company and product names mentioned here are trademarks or registered trademarks of their respective companies.

### NOTICE

- Before operating the product, read the user's manual thoroughly for proper and safe operation.
- If this product is for use with a system requiring safeguards that directly involve personnel safety, please contact the Yokogawa sales offices.
- This product is not constructed to be explosion-proof.

Subject to change without notice.

[Ed : 01/b] Copyright ©2005

Printed in Japan, 505(KP)